

Tightening torque: 75Nm

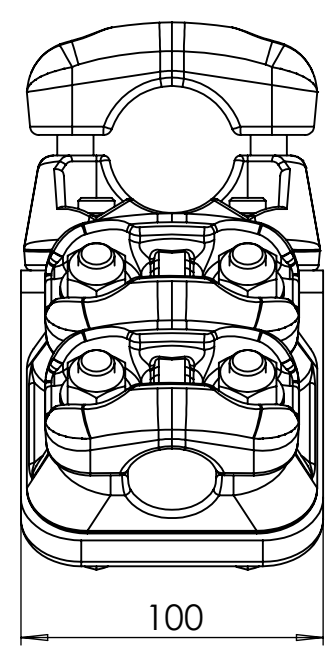
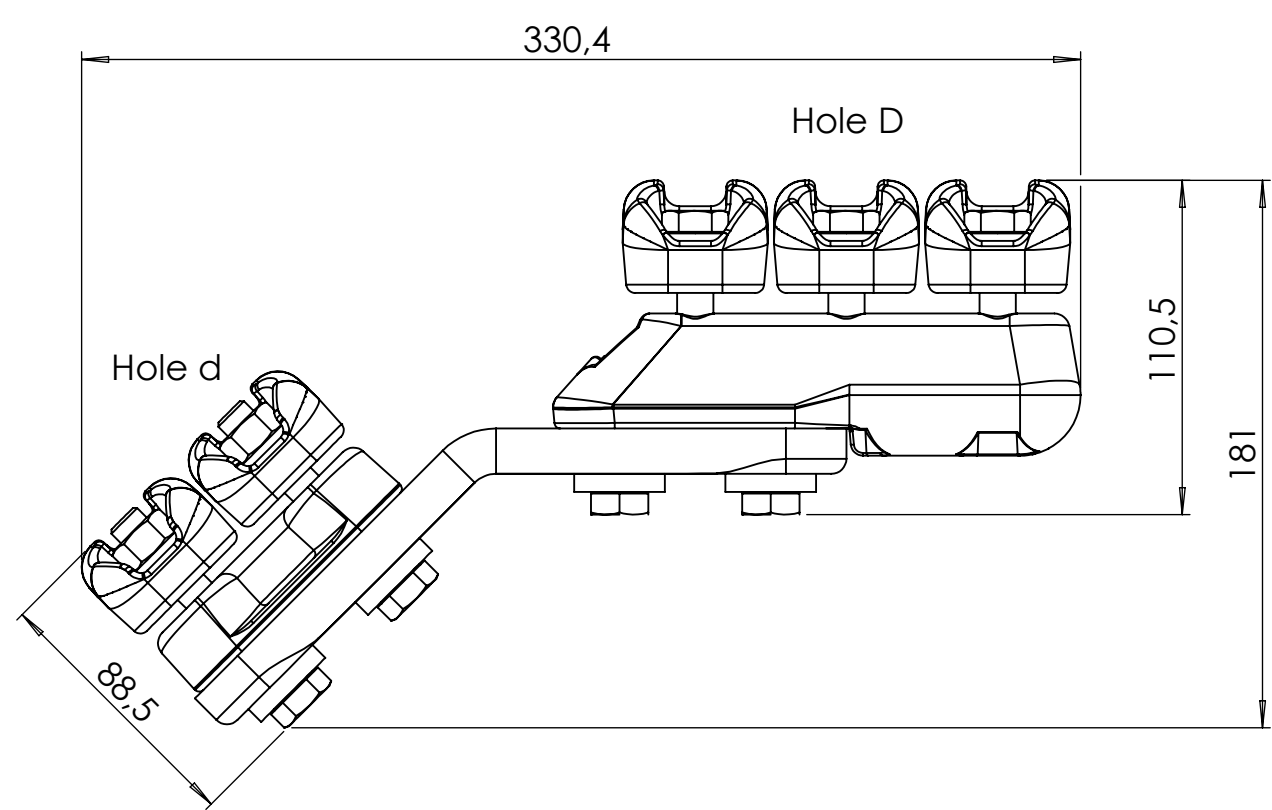

Un	245kV
In	800A
kA1s	50
Weight	3,590 kg
Hole d	Ø 17-37 mm
Hole D	Ø 37-47 mm

Merk:

DO NOT SCALE DRAWING	REVISION	1
----------------------	----------	---

M E L B Y E

TITLE:
MFK 45 gr.
al.klemme 2d+3D

	NAME	SIGNATURE	DATE
DRAWN	M.Sundler		16.12.2020
APPR.	Espen Aas		16.12.2020

DWG NO.	110302	A3
SCALE: 2:5	SHEET 1 OF 1	