

8 7 6 5 4 3 2 1

F
E
D
C
B
A

F
E
D
C
B
A

Tightening torque: 75Nm

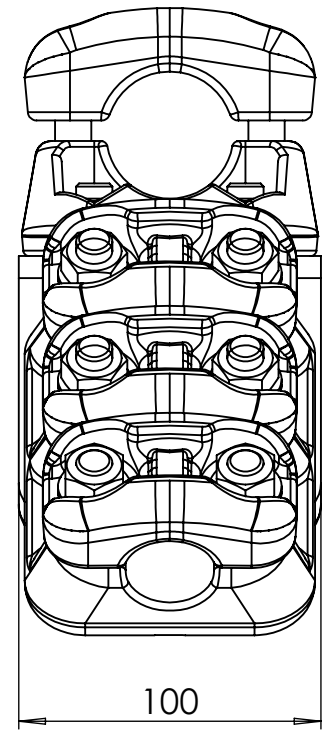
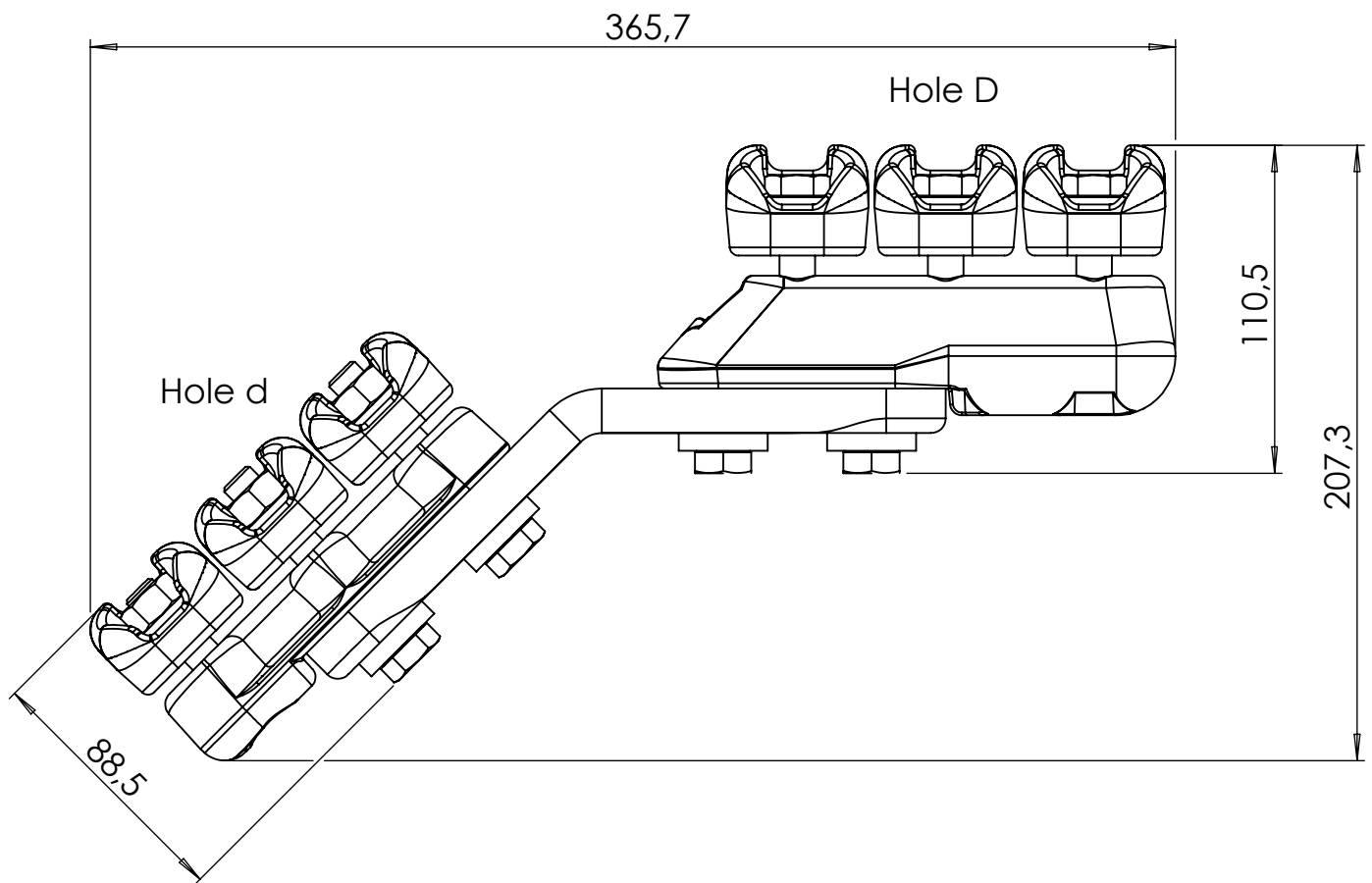
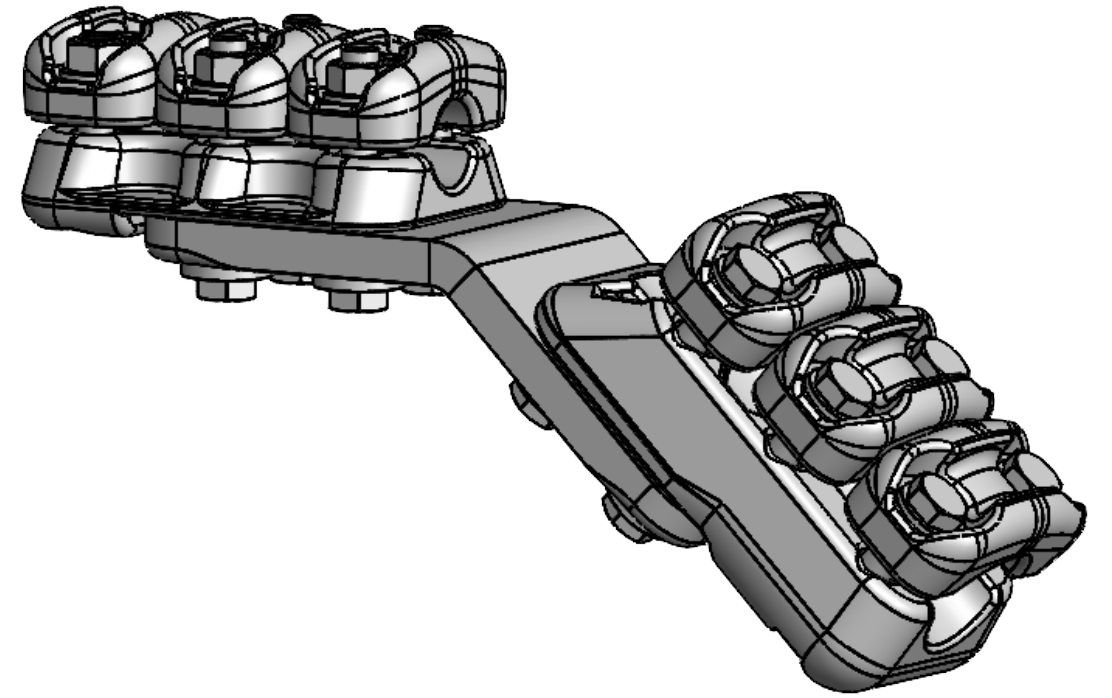

Un	245kV
In	1300A
kA1s	63
Weight	3,590 kg
Hole d	Ø 17-37 mm
Hole D	Ø 37-47 mm

Merk:

DO NOT SCALE DRAWING REVISION 1

M E L B Y E

TITLE:
**MFK 45 gr.
al.klemme 3d+3D**

	NAME	SIGNATURE	DATE
DRAWN	M.Sundler		16.12.2020
APPR.	Espen Aas		16.12.2020

DWG NO.	110306	A3
SCALE: 2:5	SHEET 1 OF 1	

8 7 6 5 4 3 2 1