

8 7 6 5 4 3 2 1

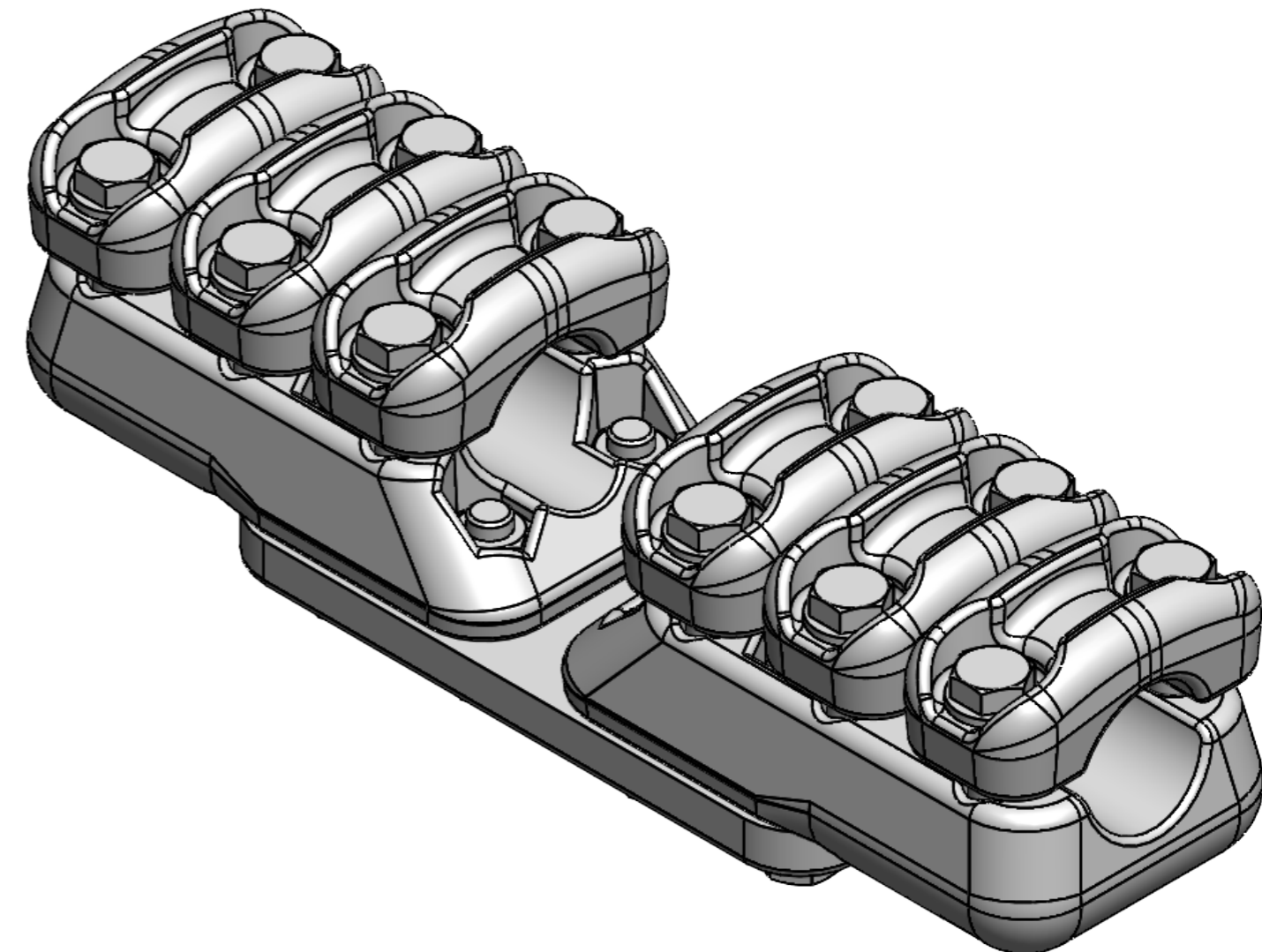

Tightening torque: 75Nm

Hole D

Hole D

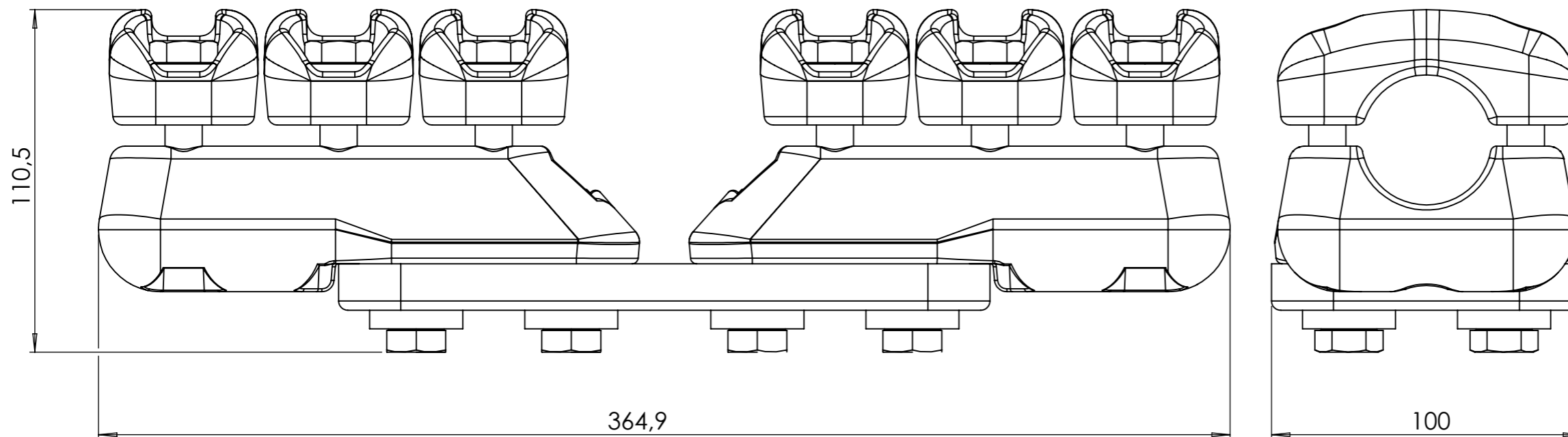

Un	245kV
In	1600A
kA1s	63
Weight	5,900 kg
Hole d	Ø 17-37 mm
Hole D	Ø 37-47 mm

Merk:

DO NOT SCALE DRAWING	REVISION	1
----------------------	----------	---

**M E L B Y E**

TITLE:  
MFK Rett  
al.klemme 3D+3D

	NAME	SIGNATURE	DATE
DRAWN	M.Sundler		14.12.2020
APPR.	Espen Aas		16.12.2020

DWG NO.	110120	A3
SCALE: 3:5	SHEET 1 OF 1	

8 7 6 5 4 3 2 1