

8 7 6 5 4 3 2 1

F  
E  
D  
C  
B  
A

F  
E  
D  
C  
B  
A

Tightening torque: 75Nm

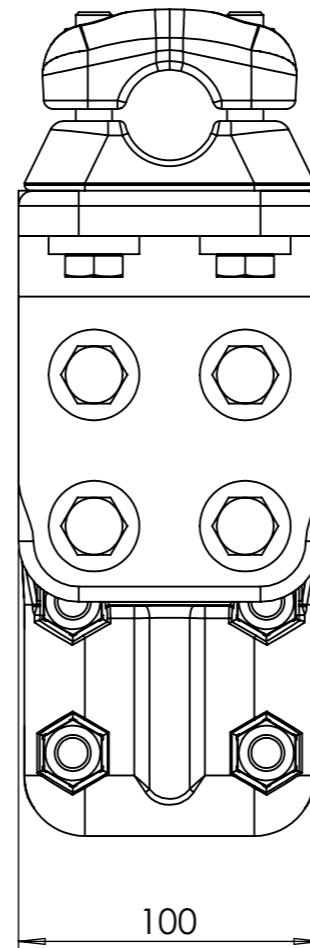
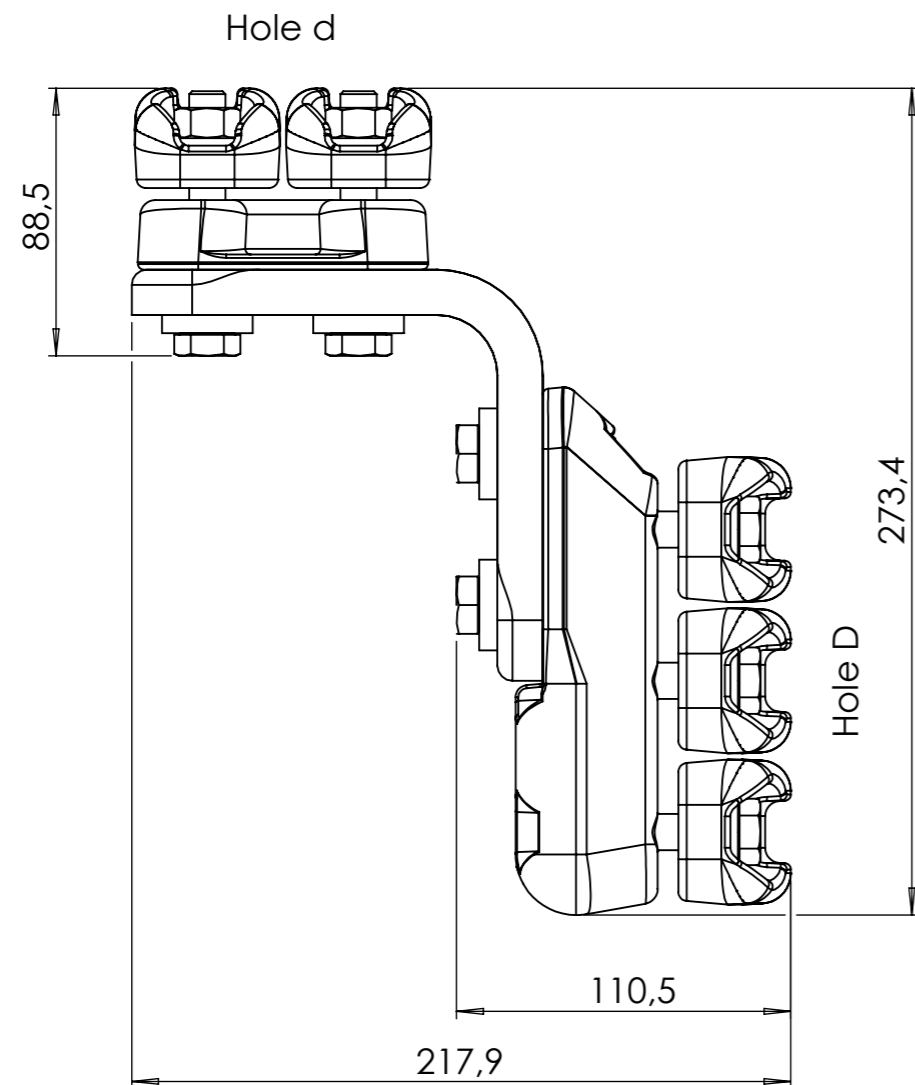
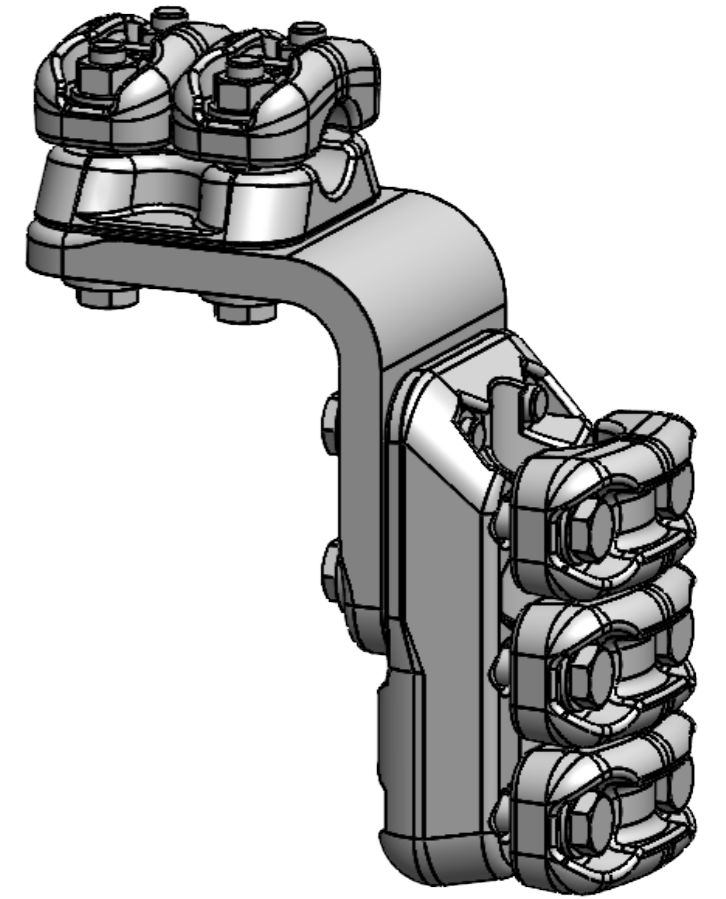

Un	245kV
In	800A
kA1s	50
Weight	4,675 kg
Hole d	Ø 17-37 mm
Hole D	Ø 37-47 mm

Merk:

DO NOT SCALE DRAWING	REVISION	1
----------------------	----------	---

**M E L B Y E**

TITLE:  
**MFK 90 gr.  
al.klemme 2d+3D**

	NAME	SIGNATURE	DATE
DRAWN	M.Sundler		16.12.2020
APPR.	Espen Aas		16.12.2020

DWG NO.	<b>110404</b>	A3
SCALE: 2:5	SHEET 1 OF 1	

8 7 6 5 4 3 2 1