

Tightening torque: 75Nm

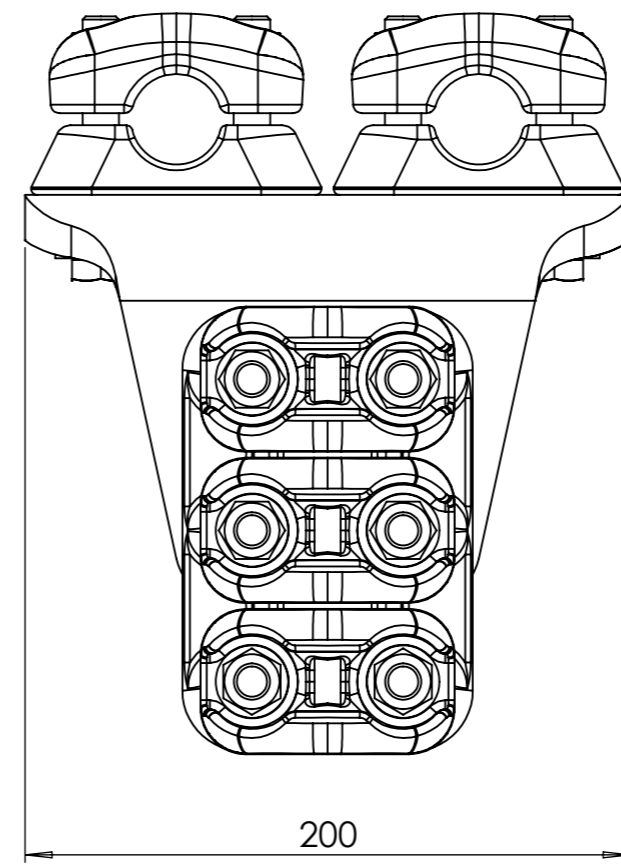
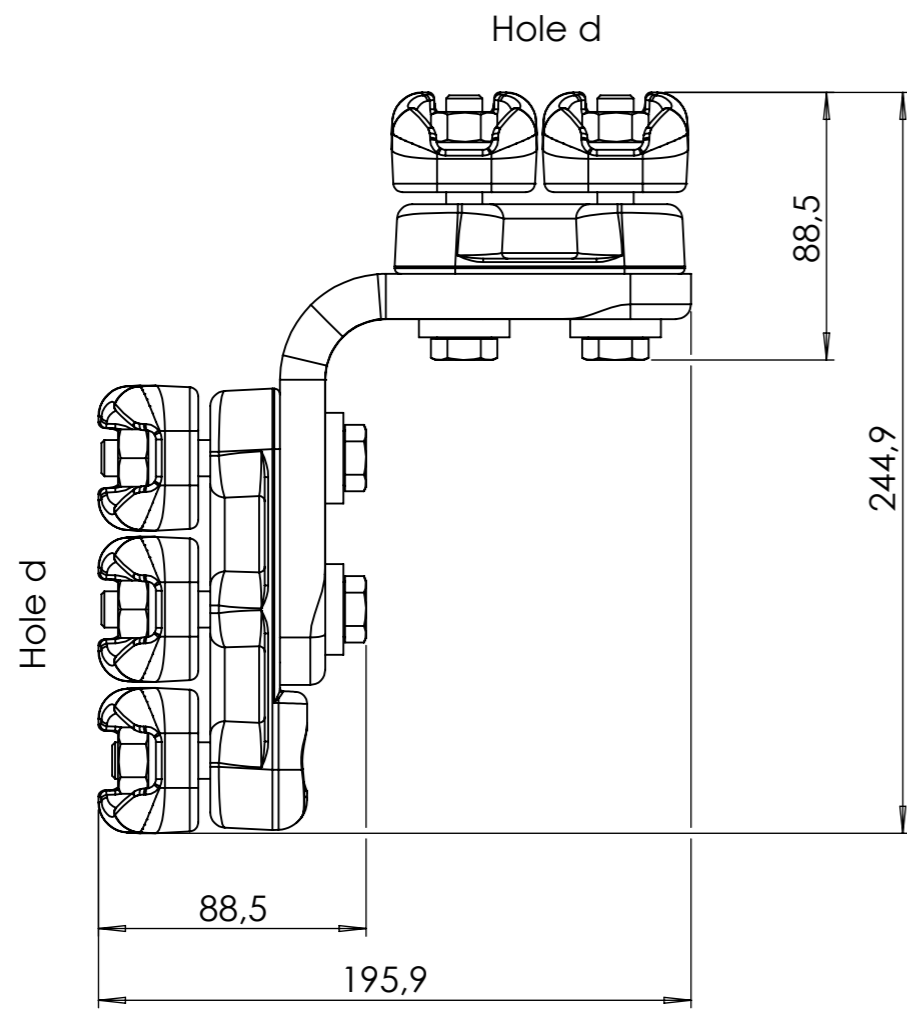

Un	245kV
In	1300A
kA1s	50
Weight	6,130 kg
Hole d	Ø 17-37 mm
Hole D	Ø 37-47 mm

Merk:

DO NOT SCALE DRAWING	REVISION	1
----------------------	----------	---

M E L B Y E

TITLE:
MFK Duplex 90 gr.
1x3d+2x2d

	NAME	SIGNATURE	DATE
DRAWN	M.Sundler		16.12.2020
APPR.	Espen Aas		16.12.2020

DWG NO.	112123	A3
SCALE: 2:5	SHEET 1 OF 1	