

This drawing and all data contained therein is legal and intellectual property of LORÜNSER Austria GmbH and must not be altered or transmitted to any third party without our written consent.

Artikel-Nr. 1BB010-020-004
Article-No.

Um	245 kV AC
In	1000 A
Ith	20 kA1s
Ith	11,6 kA3s

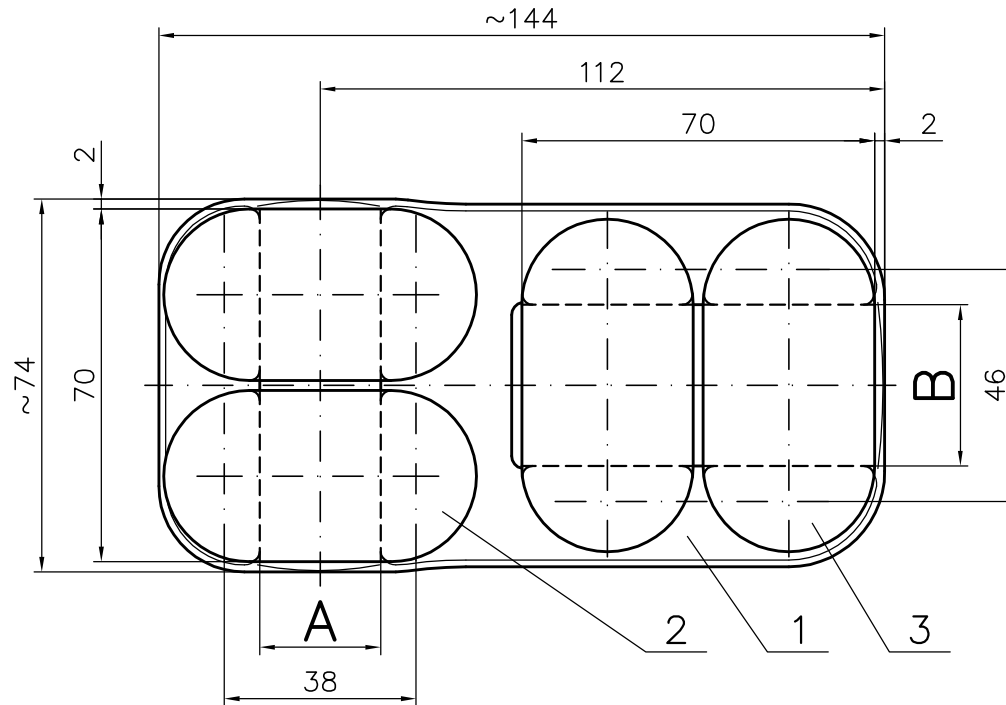
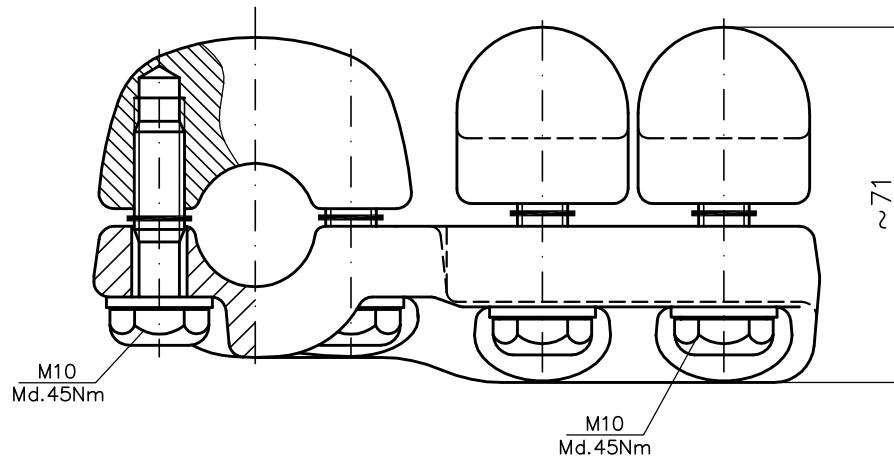

Forged type
Geschmiedete Ausführung

AL-T-Connector

Artikel-Nr. 1BB010-020-004
Article-No.

Positions-Nr. 0651656
Position-No.

Kundenprojekt Nummer ALUMINIUM TYP LTT, T-KLÄMMA LINA-TAPP
Customer Project Number

A = $\varnothing 19,9$

Datum/Name Date/Name	Nr. No.
02.05.2006 Fedor	569

Datum/Name Date/Name	Gewicht Weight	~1,2 Kg
-------------------------	-------------------	---------

Projekt-Nr.
Project-No.

Bemerkung
Comments

B = $\varnothing 30$

gez. drawn	15.12.1986 Schuster	Maßstab Scale	1:1,5
---------------	---------------------	------------------	-------

Änderung Revision	Datum Date
----------------------	---------------

C =



gepr. appr.	15.12.1986 Jazbec	Werkzeuge früher	vorh.
----------------	-------------------	---------------------	-------

LL-Bezug
LL-Reference

D =

Bauteil-Nr.
Components

