

This drawing and all data contained therein is legal and intellectual property of LORÜNSER Austria GmbH and must not be altered or transmitted to any third party without our written consent.

Artikel-Nr. 1PA500-409-004
Article-No.

Un	420 kVAC
In	1300 A
Ith	50 kA1s
Ith	28,9 kA3s

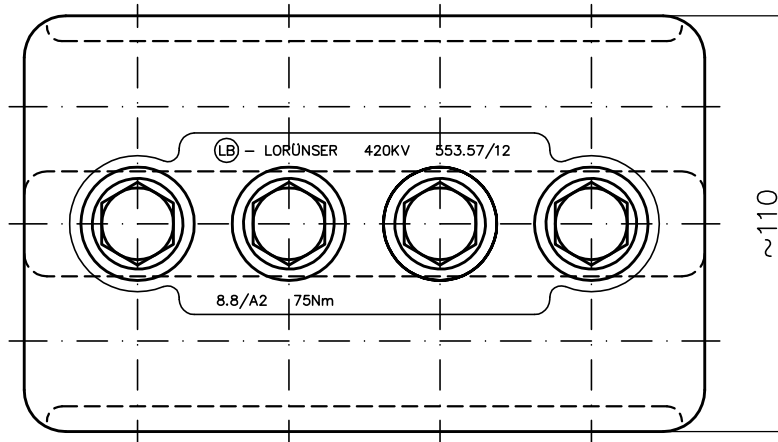
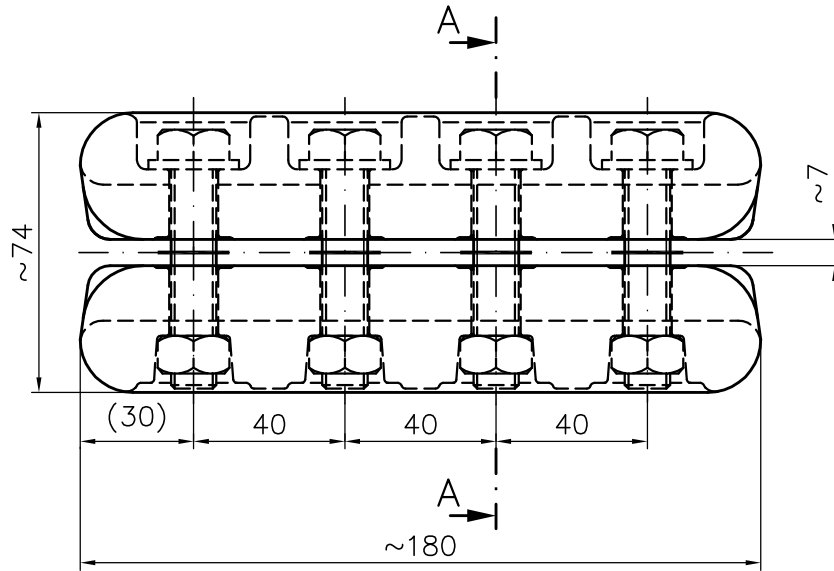

Schnitt: A-A
section: A-A

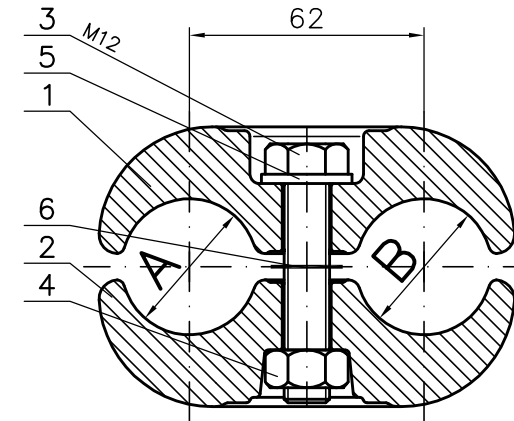

Forged Type
Geschmiedete Ausführung

AL-Parallel-Groove-Clamp

Positions-Nr. 0651850
Position-No.

Kundenprojekt Nummer ALUMINIUM TYP LLP, PARALLEL LINA-LINA
Customer Project Number

A = $\varnothing 39,2$

Datum/Name Date/Name	Nr. No.
01.08.2006 Tosetti	569

Artikel-Nr. 1PA500-409-004
Article-No.

Datum/Name
Date/Name

Gewicht
Weight

~2,7 Kg

Projekt-Nr.
Project-No.

Bemerkung
Comments

B = $\varnothing 36,2$

gez. drawn
Date/Name

Maßstab
Scale

1:2

Änderung
Revision

Datum
Date

C =



gepr. appr.
Date/Name

Werkzeuge
Tools

vorh.
früher

LL-Bezug
LL-Reference

D =

Bauteil-Nr.
Components

