

DETAIL C

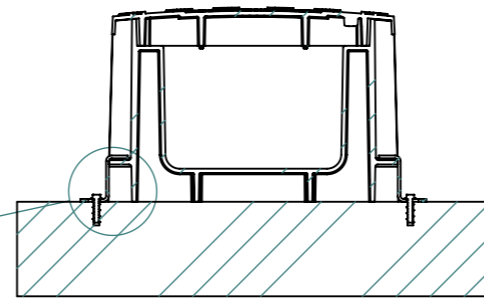

SECTION B-B

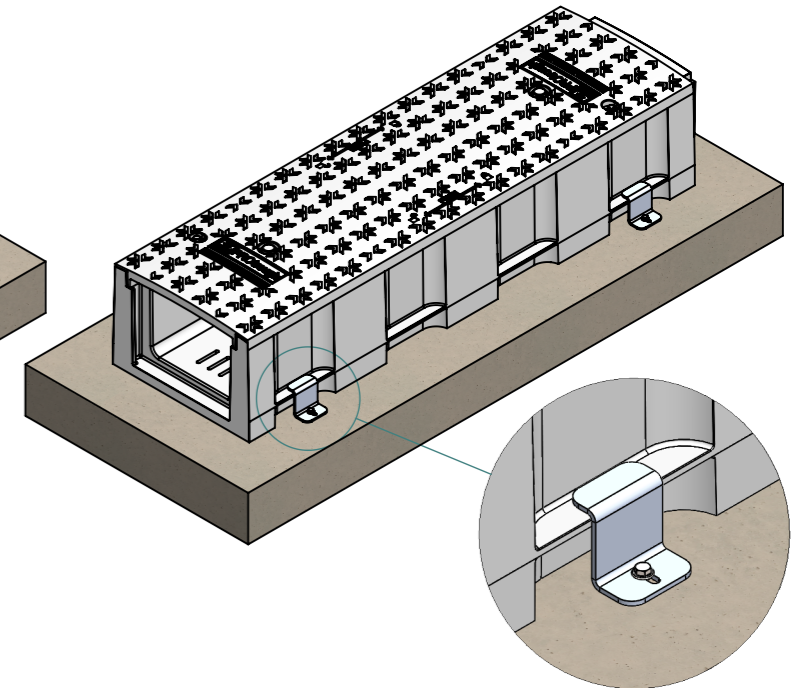
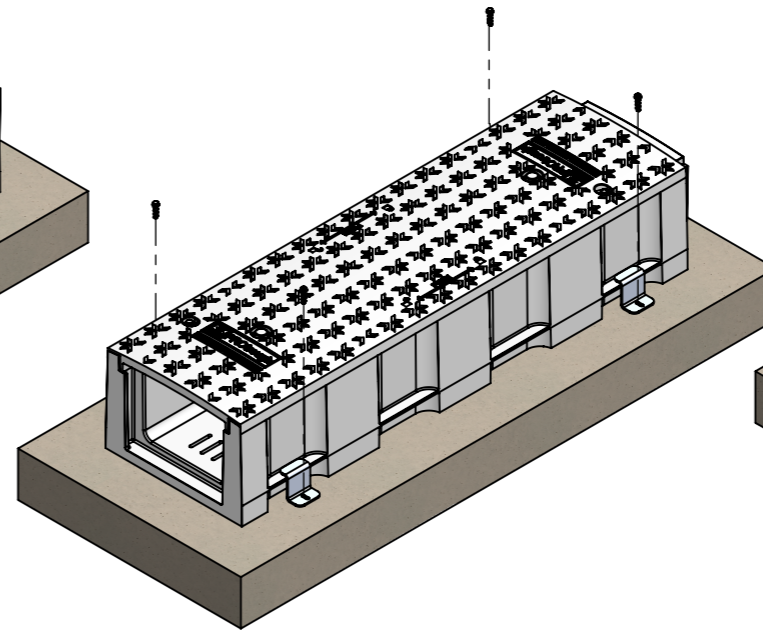
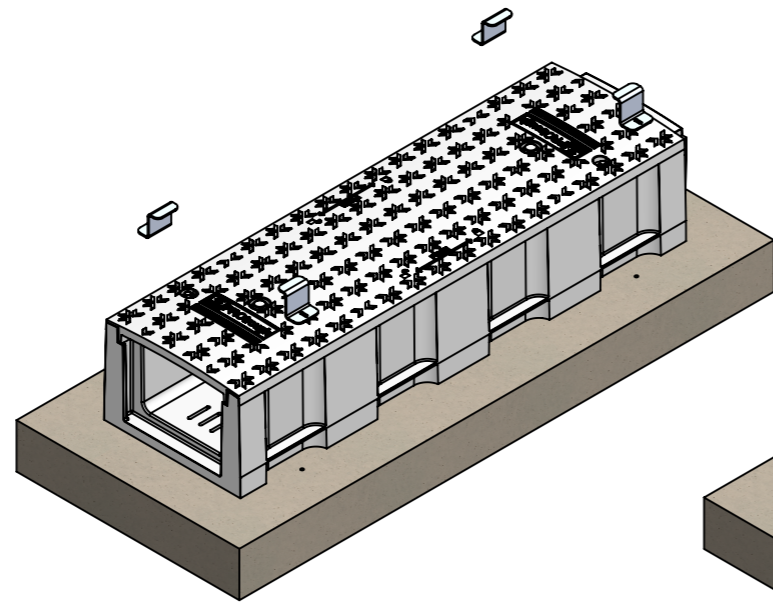
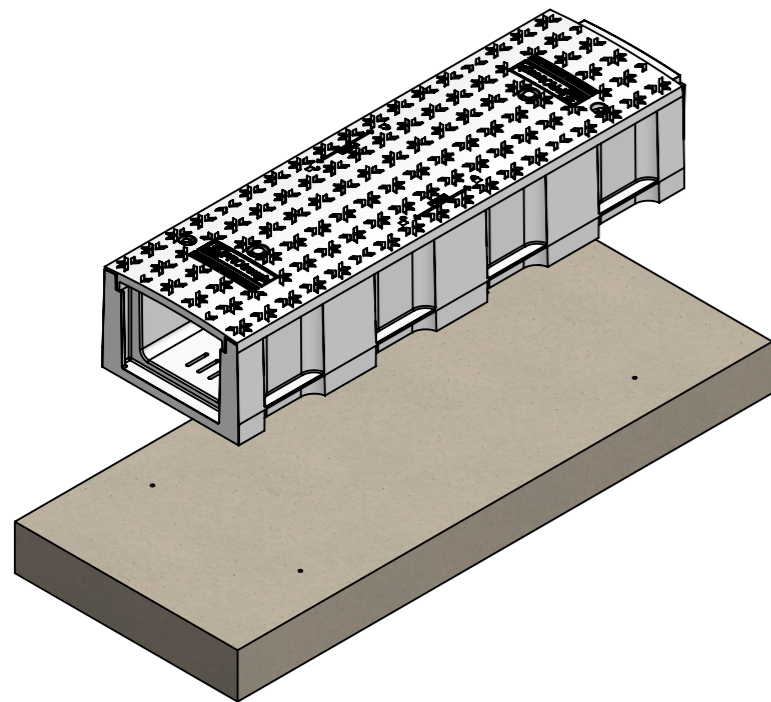
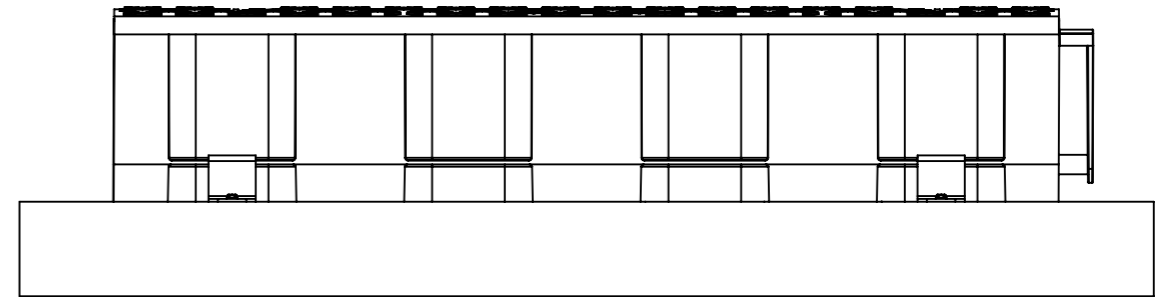
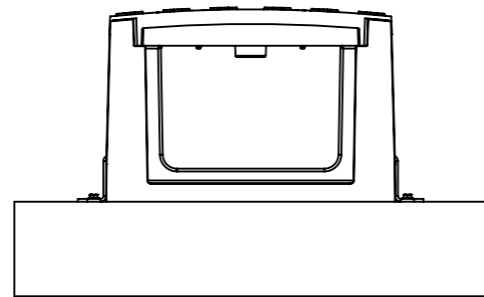
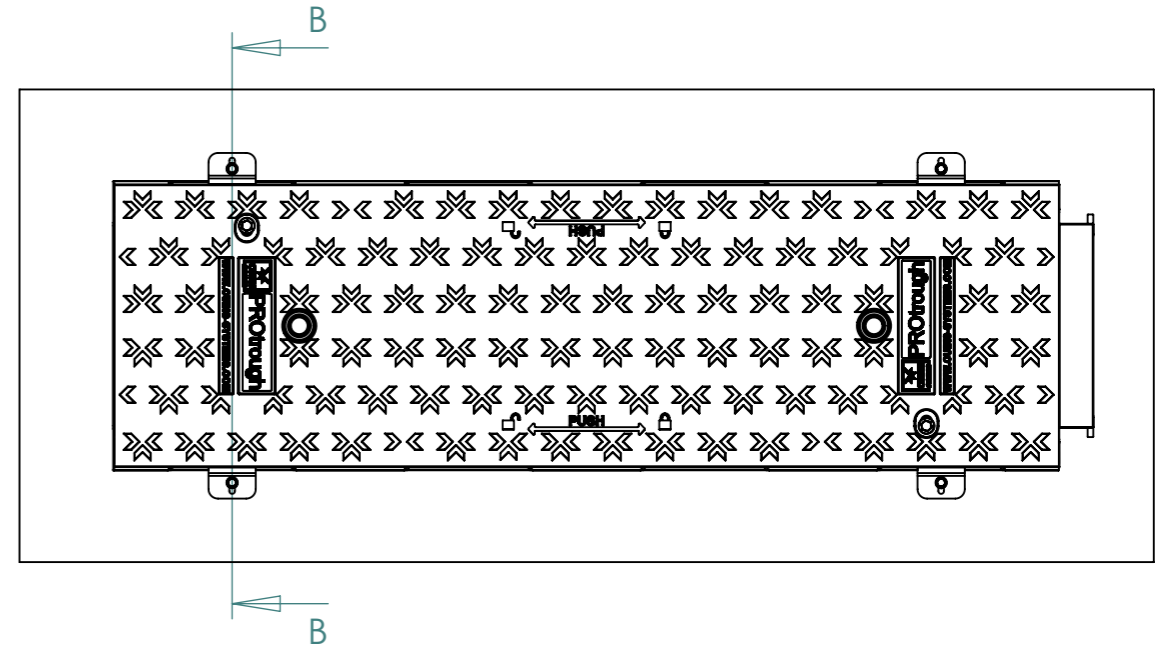

DETAIL D



Copyright of Cubis Systems. No part of this document may be communicated, copied or used without prior permission of Cubis Systems.
www.cubis-systems.com

Date 05/03/21
Drawn S.Evans
Appr.

Third Angle Projection
Weight

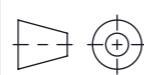

Material
Finish
Tolerance unless Otherwise Stated
DIMS
mm

TITLE
PROtrough Bridge Deck Securing Feature

SIZE A3
DWG NO 10903401
SHEET 1 OF 1
REV

Rev	Date	Revision History: Description	Drwn	Appr
.	--/--/--	.	.	.
.	--/--/--	.	.	.
.	--/--/--	.	.	.
.	--/--/--	.	.	.