

Product name	MFK 90 degree substation connector 2d+3D 17-37mm/37-47mm
Product code	110404
Product type	MFK 90 gr 2d+3D
GTIN	7332811350436
ETIM-Class	

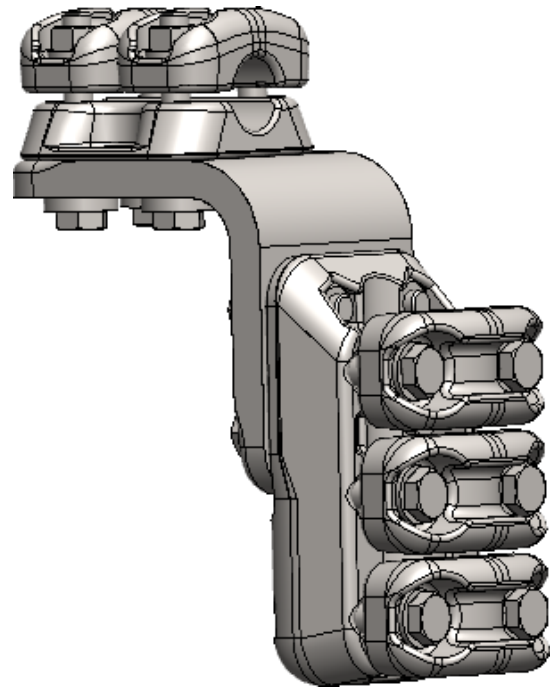

Measurements

Weight	4 675 g
--------	---------

Technical informations - Clamps

Weight	4 675 g
Load In	800 A
Max Rated Voltage Un	245 kV
Short Circuit Current kA 1s	50 kA

Load / Tension Data

Wrench Size	19 mm
Torque	75 Nm

Specifications

Conductor Diameter Main	37-47 mm
Conductor Diameter Tap	17-37 mm
Hole Diameter d	17-37 mm
Hole Diameter D	37-47 mm
Number of Caps	2+3

