

Product name	MFK 90 degree substation connector 3d+2D 17-37mm/37-47mm
Product code	110405
Product type	MFK 90 gr 3d+2D
GTIN	7332811350443
ETIM-Class	

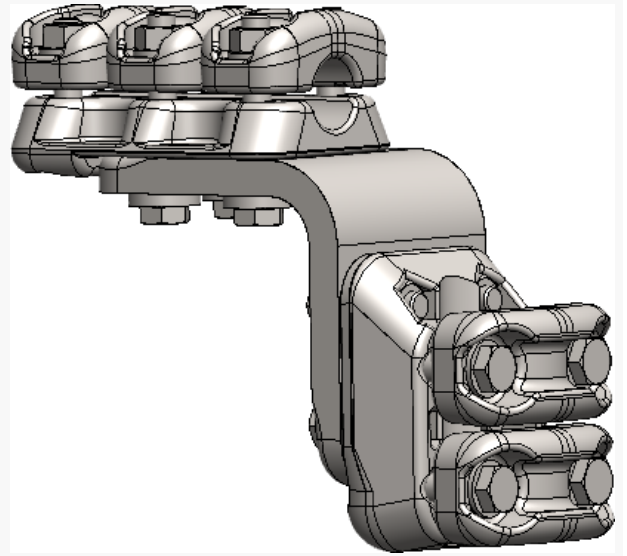

## Measurements

Weight	4 515 g
--------	---------

## Technical informations - Clamps

Weight	4 515 g
Load In	1000 A
Max Rated Voltage Un	245 kV
Short Circuit Current kA 1s	50 kA

## Load / Tension Data

Wrench Size	19 mm
Torque	75 Nm

## Specifications

Conductor Diameter Main	37-47 mm
Conductor Diameter Tap	17-37 mm
Hole Diameter d	17-37 mm
Hole Diameter D	37-47 mm
Number of Caps	3+2

