

Product name	MFK Duplex 90 degree 1 × 37-47mm 3D 2 × 17-37mm 2d
Product code	112124
Product type	MFK Duplex 90 gr 1×3D+2×2d
GTIN	7332811350894
ETIM-Class	

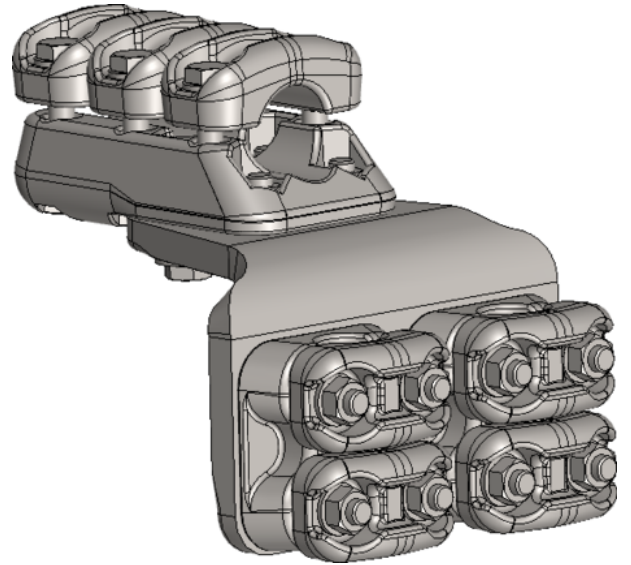

Measurements

Weight	7 338 g
--------	---------

Technical informations - Clamps

Bolt dimension / number mm / pcs	m12
Weight	7 338 g
Load In	1600 A
Max Rated Voltage Un	245 kV
Short Circuit Current kA 1s	50 kA

Load / Tension Data

Wrench Size	19
Torque	75 Nm

Specifications

Conductor Diameter Main	37-47 mm
Conductor Diameter Tap	17-37 mm
Hole Diameter d	17-37 mm
Hole Diameter D	37-47 mm
Number of Caps	1×3d+2×2d

