

| | |
|--------------|---|
| Product name | Counterweight device for AGS-clamp Counterweight device for |
| Product code | 0626549 |
| Product type | 4370.57/13 |
| GTIN | 7332811074479 |
| ETIM-Class | |

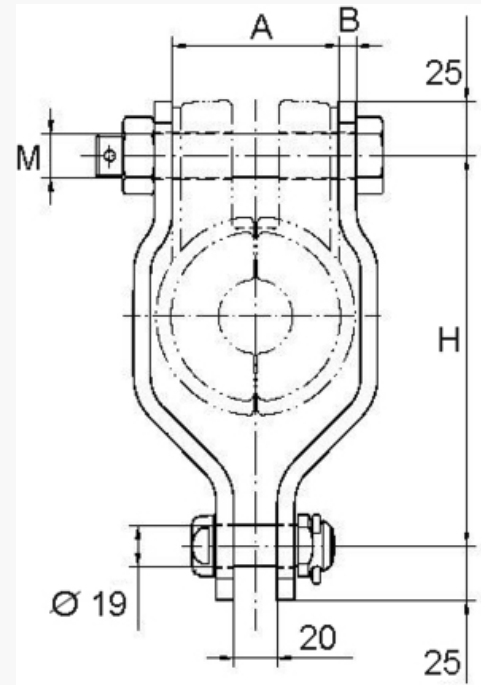

Measurements

| | |
|--------|---------|
| Length | 280 mm |
| Height | 40 mm |
| Width | 150 mm |
| Weight | 2 200 g |

Technical Specifications - String Hardware

| | |
|-------------------------|-------------------------|
| Bolt Diameter | 19 mm |
| Conductor Diameter | 34,44-39,55 mm |
| Conductor Cross Section | 772-910 mm ² |
| Material | varmgalvaniserat stål |
| Dimension A | 105 mm |
| Dimension h | 230 mm |
| Dimension M | m16 mm |