

Product name	MFC connector 2d ø17-37mm Processed
Product code	113018
GTIN	7332811388705
ETIM-Class	

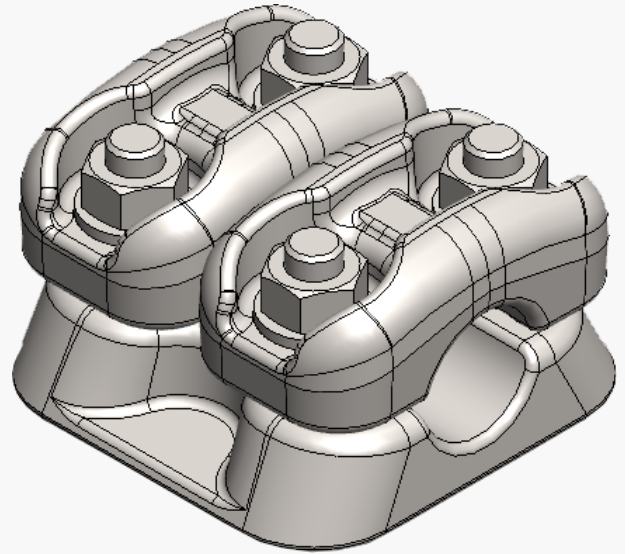

Measurements

Weight	1190 g
--------	--------

Technical informations - Clamps

Bolt dimension / number mm / pcs	m12
Load In	800 A
Max Rated Voltage Un	245 kV
Short Circuit Current kA 1s	50 kA

Load / Tension Data

Wrench Size	19
Torque	75 Nm

Specifications

Conductor Diameter Main	17-37 mm
Hole Diameter d	17-37 mm
Number of Caps	2