

| | |
|--------------|--|
| Product name | MFK T-substation connector 3d+2D 17-37mm/37-47mm |
| Product code | 110216 |
| Product type | MFK T 3d+2D |
| GTIN | 7332811341281 |
| ETIM-Class | |

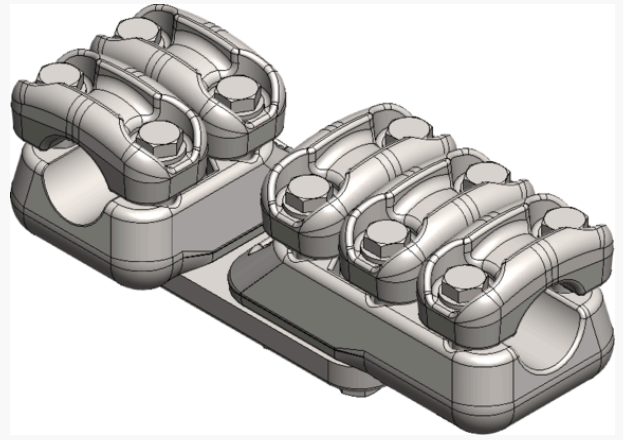

Measurements

| | |
|--------|---------|
| Weight | 4 384 g |
|--------|---------|

Technical informations - Clamps

| | |
|----------------------------------|---------|
| Bolt dimension / number mm / pcs | m12 |
| Weight | 4 384 g |
| Load In | 1000 A |
| Max Rated Voltage Un | 245 kV |
| Short Circuit Current kA 1s | 50 kA |

Load / Tension Data

| | |
|-------------|-------|
| Wrench Size | 19 mm |
| Torque | 75 Nm |

Specifications

| | |
|-------------------------|----------|
| Conductor Diameter Main | 37-47 mm |
| Conductor Diameter Tap | 37-47 mm |
| Hole Diameter d | 17-37 mm |
| Hole Diameter D | 37-47 mm |
| Number of Caps | 2+3 |

