

Product name	MFK Duplex 45 degree 1 × 37-47mm 2D 2 × 17-37mm 3d
Product code	112114
Product type	MFK Duplex 45 gr 1×2D+2×3d
GTIN	7332811350795
ETIM-Class	

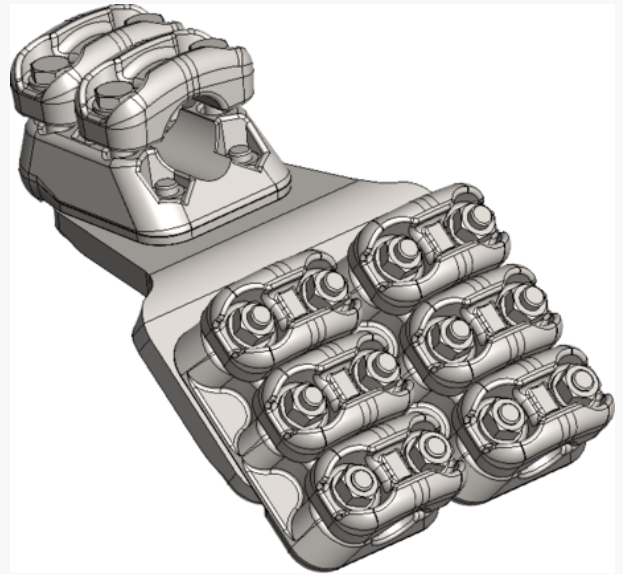

Measurements

Weight	6 587 g
--------	---------

Technical informations - Clamps

Bolt dimension / number mm / pcs	m12
Weight	6 587 g
Load In	1000 A
Max Rated Voltage Un	245 kV
Short Circuit Current kA 1s	50 kA

Load / Tension Data

Wrench Size	19
Torque	75 Nm

Specifications

Conductor Diameter Main	37-47 mm
Conductor Diameter Tap	17-37 mm
Hole Diameter d	17-37 mm
Hole Diameter D	37-47 mm
Number of Caps	1×2d+2×3d

