

Product name	MFK Duplex 45 degree 1 x 37-47mm 3D 2 x 17-37mm 2d
Product code	112116
Product type	MFK Duplex 45 gr 1x3D+2x2d
GTIN	7332811350818
ETIM-Class	

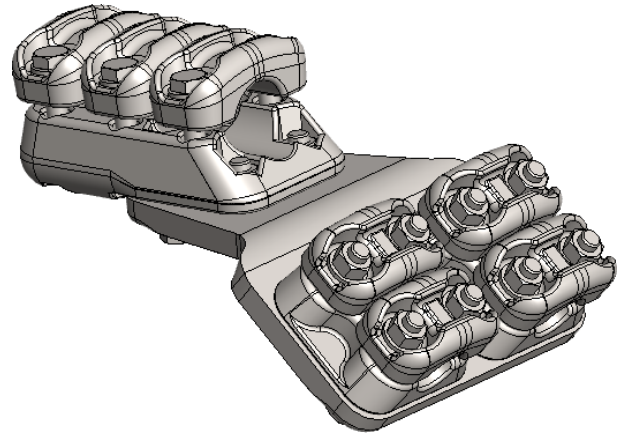

Measurements

Weight	7 338 g
--------	---------

Technical informations - Clamps

Bolt dimension / number mm / pcs	m12
Weight	7 338 g
Load In	1600 A
Max Rated Voltage Un	245 kV
Short Circuit Current kA 1s	50 kA

Load / Tension Data

Wrench Size	19
Torque	75 Nm

Specifications

Conductor Diameter Main	37-47 mm
Conductor Diameter Tap	17-37 mm
Hole Diameter d	17-37 mm
Hole Diameter D	37-47 mm
Number of Caps	1x3d+2x2d

